

DUAL LINE OUTPUT MODULE 1:1 BIFILAR WINDINGS

- Distortion 0.035% typ at 20 Hz and +4 dBu output level
- Wide bandwidth: -3 dB at 0.2 Hz and 15 MHz
- Drives 600 Ω loads to levels up to +21 dBu at 20 Hz
- Excellent time domain performance: DLP 0.3° typ 20 Hz to 20 kHz
- Insertion loss only 1.6 dB when driving 600 Ω load

This module is designed for high performance line output stages. The 50% nickel alloy core gives it excellent distortion and level handling at a cost allowing many applications to enjoy the advantages of an output transformer. Driving signals should be free of DC and source impedance kept as low as possible.

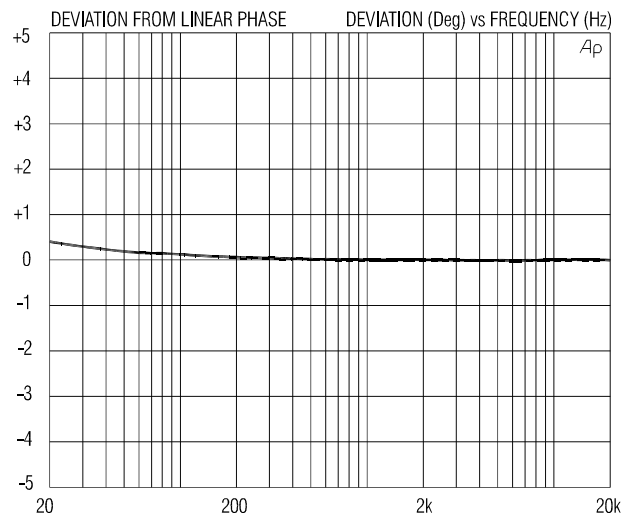

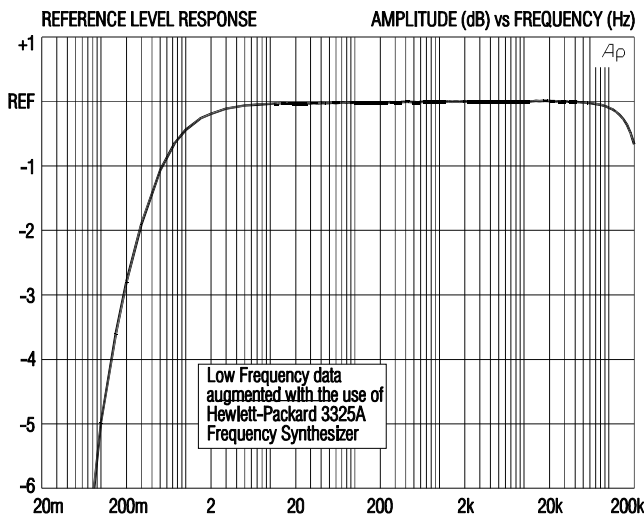
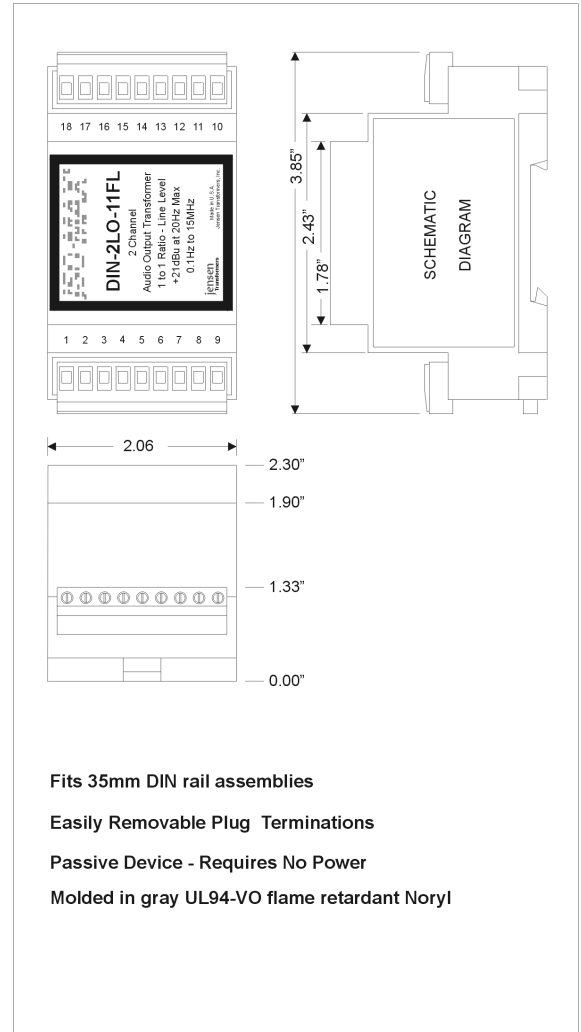
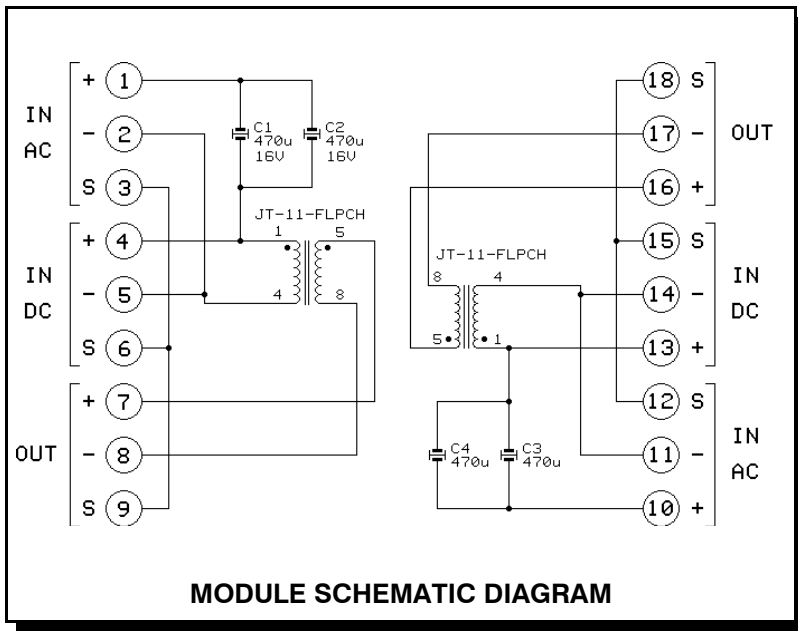
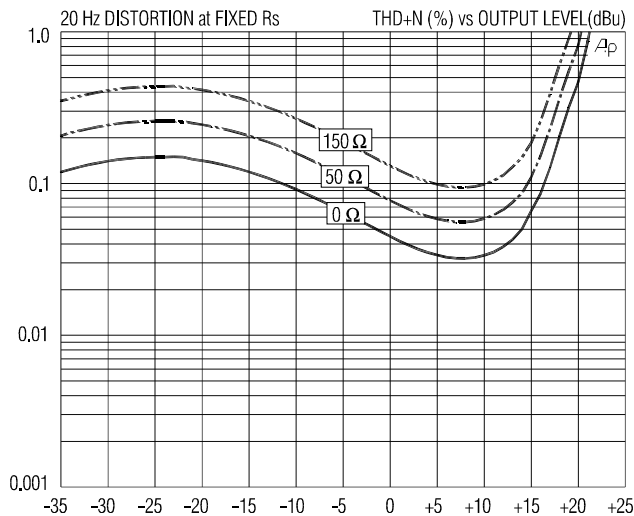
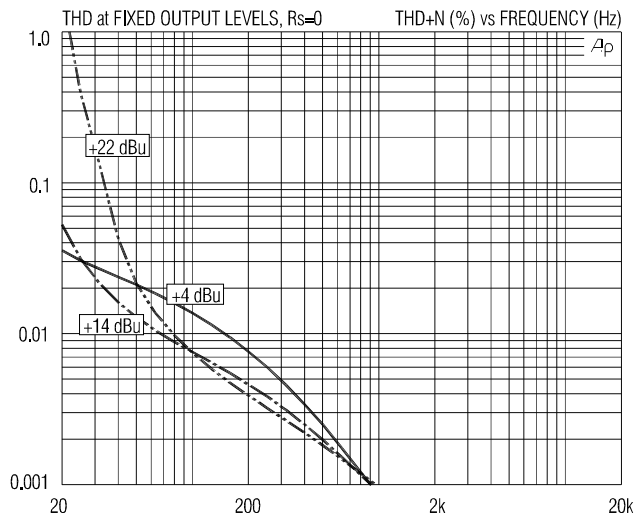

DIN -2LO -11FL SPECIFICATIONS (all levels are output unless noted)

PARAMETER	CONDITIONS	MINIMUM	TYPICAL	MAXIMUM
Input impedance, Z_i	20 Hz to 20 kHz, 0 dBu, test circuit 3	705 Ω	716 Ω	725 Ω
Voltage gain	1 kHz, 0 dBu, test circuit 1, $R_s=0 \Omega$	-1.8 dB	-1.6 dB	-1.4 dB
Magnitude response, ref 1 kHz	20 Hz, 0 dBu, test circuit 1, $R_s=0 \Omega$	-0.10 dB	-0.03 dB	± 0.00 dB
	20 kHz, 0 dBu, test circuit 1, $R_s=0 \Omega$	-0.10 dB	± 0.00 dB	+0.10 dB
Deviation from linear phase (DLP)	20 Hz to 20 kHz, 0 dBu, test circuit 1, $R_s=0 \Omega$		+0.3/-0°	$\pm 1.0^\circ$
Bandwidth	LF -3 dB re 1 kHz, test circuit 1, $R_s=0 \Omega$		0.20 Hz	
	HF -3 dB re 1 kHz, test circuit 1, $R_s=0 \Omega$		15 MHz	
Distortion (THD)	1 kHz, +4 dBu, test circuit 1, $R_s=0 \Omega$		<0.001%	
	20 Hz, +4 dBu, test circuit 1, $R_s=0 \Omega$		0.035%	0.15%
Maximum output level	20 Hz, 1% THD, test circuit 1, $R_s=0 \Omega$	+19 dBu	+21 dBu	
Common-mode rejection ratio (CMRR)	60 Hz, test circuit 2		94 dB	
	3 kHz, test circuit 2	75 dB	83 dB	
Output impedance, Z_o	20 Hz to 20 kHz, 0 dBu, test circuit 4		116 Ω	
DC resistance	each winding		58 Ω	
Capacitance	winding to winding, 1 kHz		24 nF	
	winding to frame, 1 kHz		35 pF	
Turns ratio		0.999:1	1.000:1	1.001:1
Temperature range	operation or storage	0° C		70° C
Breakdown voltages 60 Hz, 1 minute test duration (see IMPORTANT NOTE below)	winding to winding	250 V RMS		
	winding to frame	500 V RMS		

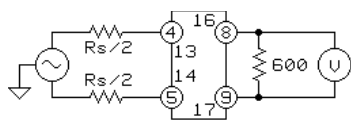

TEST CIRCUIT 1

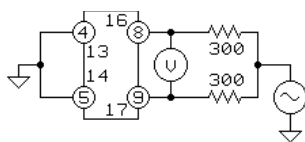

TEST CIRCUIT 2

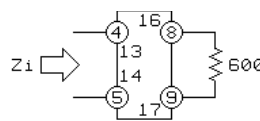

TEST CIRCUIT 3

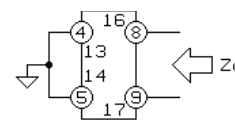

TEST CIRCUIT 4

All minimum and maximum specifications are guaranteed. Unless noted otherwise, all specifications apply at 25°C. Specifications subject to change without notice. All information herein is believed to be accurate and reliable, however no responsibility is assumed for its use nor for any infringements of patents which may result from its use. No license is granted by implication or otherwise under any patent or patent rights of Jensen Transformers, Inc.

IMPORTANT NOTE: This device is NOT intended for use in life support systems or any application where its failure could cause injury or death. The breakdown voltage specification is intended to insure integrity of internal insulation systems; continuous operation at these voltages is NOT recommended. Consult our applications engineering department if you have special requirements.

JENSEN TRANSFORMERS, INC., 7135 Hayvenhurst Avenue, Van Nuys, CA 91406-3807, USA
(818) 374-5857 • FAX (818) 374-5856 • www.jensen-transformers.com