

PC AUDIO GROUND ISOLATOR
STOPS HUM AND BUZZ IN PC/MULTIMEDIA INTERFACES

- *Eliminates the inherent ground noise coupling mechanism*
- *Common-mode ground noise rejection of 95 dB at 60 Hz*
- *Wide bandwidth: -3 dB at 0.25 Hz and 50 kHz*
- *Handles signals up to 7 volts at 20 Hz or 11 volts at 30 Hz*
- *Input impedances are 49 kΩ when driving typical 47 kΩ inputs*

When used in unbalanced audio consumer interfaces, this isolator not only eliminates hum and buzz but also enhances audio quality by reducing "spectral contamination" due to ultrasonic and RF interference. To avoid excessive high frequency losses, no more than 3 feet of cable should be used on its outputs.

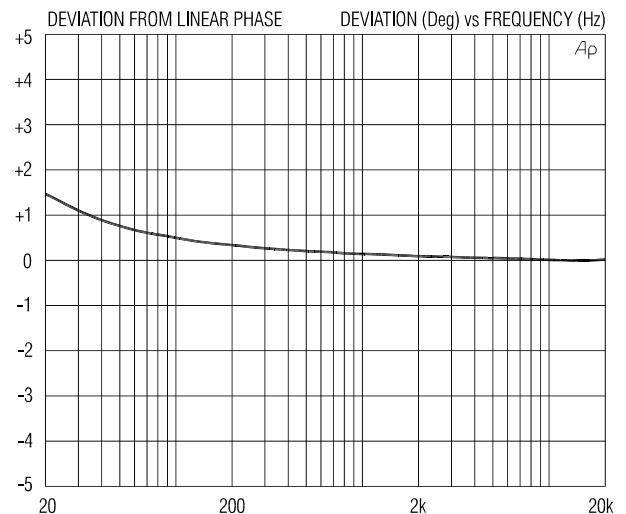

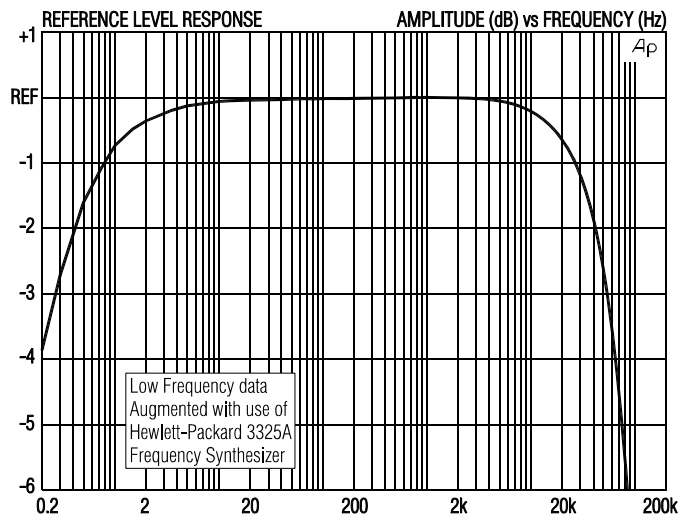
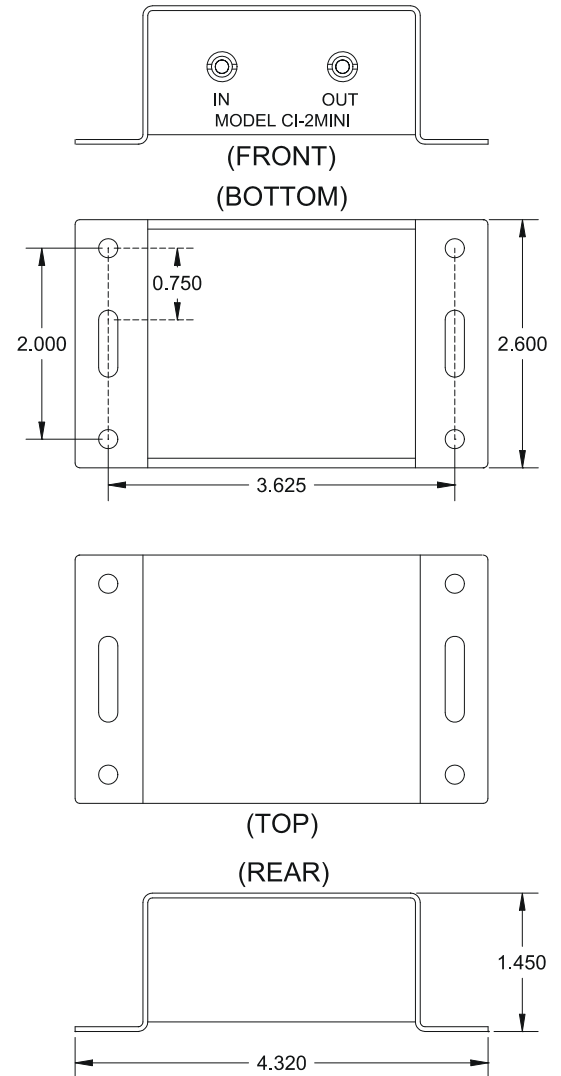
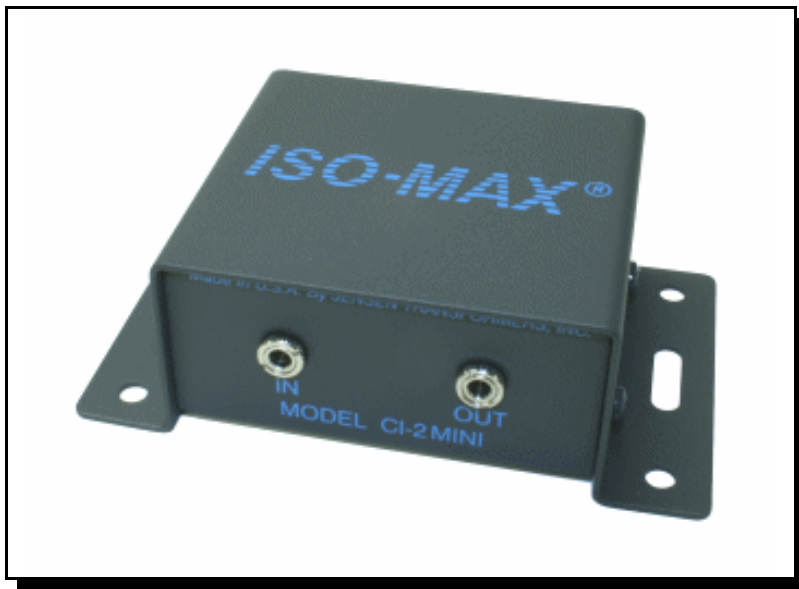
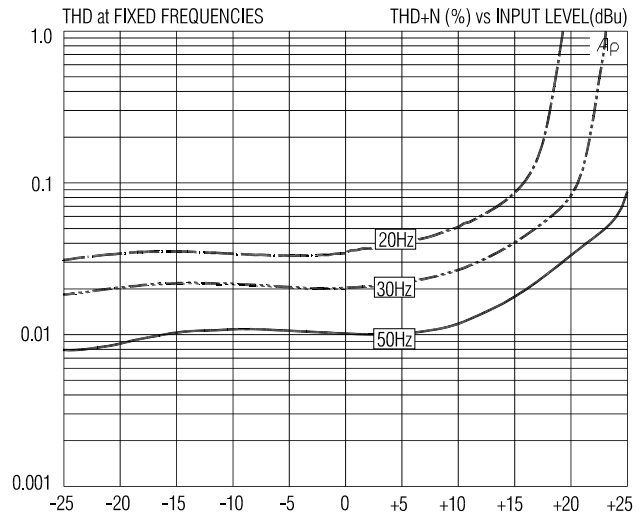
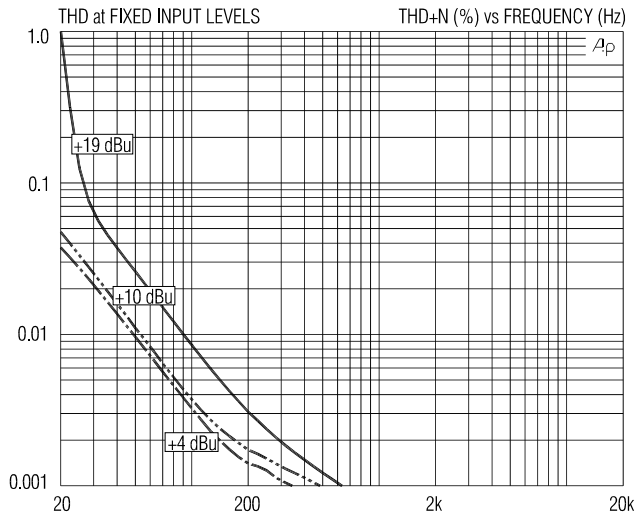

CI-2MINI SPECIFICATIONS (all levels are input unless noted, +4 dBu = 1.23 V RMS)

PARAMETER	CONDITIONS	MINIMUM	TYPICAL	MAXIMUM
Input impedance, Zi	1 kHz, +4 dBu, test circuit 1	47.0 kΩ	48.6 kΩ	50.0 kΩ
Insertion Loss	1 kHz, +4 dBu, test circuit 1		0.82 dB	1.0 dB
Magnitude response, ref 1 kHz	20 Hz, +4 dBu, test circuit 1	-0.15 dB	-0.03 dB	±0.0 dB
	20 kHz, +4 dBu, test circuit 1	-1.0 dB	-0.70 dB	±0.0 dB
Deviation from linear phase (DLP)	20 Hz to 20 kHz, +4 dBu, test circuit 1		+1.4/-0°	±2.0°
Distortion (THD)	1 kHz, +4 dBu, test circuit 1		<0.001%	
	20 Hz, +4 dBu, test circuit 1		0.04%	0.10%
Maximum 20 Hz input level	1% THD, test circuit 1	+17 dBu	+19 dBu	
Common-mode rejection ratio (CMRR)	60 Hz, test circuit 2		95 dB	
	3 kHz, test circuit 2		85 dB	
Output impedance, Zo	1 kHz, test circuit 1		4.65 kΩ	
DC resistances	input		2.26 kΩ	
	output		1.90 kΩ	
Capacitance	1 kHz, input to output		105 pF	
Allowable source impedance	(output impedance of device driving the ISO-MAX input)	0	600 Ω	2 kΩ
Allowable load impedance	(input impedance of device loading the ISO-MAX output)	10 kΩ	47 kΩ	∞
Allowable load capacitance	(cable & input capacitance loading the ISO-MAX output)	0	50 pF	100 pF
Temperature range	operation or storage	0° C		70° C
Input to Output Voltage Difference (see IMPORTANT NOTE below)	any input to any output shield or any shield to case, 60 Hz			24 V RMS 34 V peak

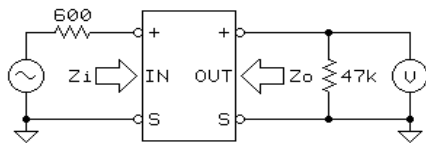

TEST CIRCUIT 1

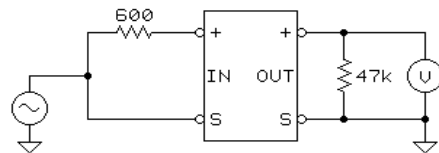

TEST CIRCUIT 2

All minimum and maximum specifications are guaranteed. Unless noted otherwise, all specifications apply at 25°C. Specifications subject to change without notice. All information herein is believed to be accurate and reliable, however no responsibility is assumed for its use nor any infringements of patents which may result from its use. No license is granted by implication or otherwise under any patent or patent rights of Jensen Transformers, Inc.

IMPORTANT NOTE: THIS PRODUCT IS NOT INTENDED FOR USE IN CIRCUMSTANCES WHERE THE DC OR PEAK AC VOLTAGE BETWEEN INPUT AND OUTPUT CONNECTIONS EXCEEDS 34 VOLTS OR WHERE ITS FAILURE COULD CAUSE INJURY OR DEATH.

**JENSEN TRANSFORMERS, INC., 9304 Deering Avenue, Chatsworth, CA 91311-5857, USA
(818) 374-5857 • FAX (818) 374-5856 • www.jensen-transformers.com**