

Moving Coil Transformer

1:10 STEP-UP FOR MC CARTRIDGES UP TO 45 Ω

- Adds 20dB of low noise, low distortion gain to RIAA preamps
- Good bandwidth: -3 dB at 2 Hz and 180 kHz
- Deviation from Linear Phase only 4° typical at 20Hz
- Proper loading provided by standard 47 kΩ phono input
- High common-mode rejection: 120 dB at 60 Hz

This transformer, with its 4 kΩ secondary source impedance and 20 dB (≈10x) voltage gain, provides excellent signal-to-noise with standard phono preamps. The primary is fully balanced and its leads may be reversed to invert polarity. Nested double (60 dB) magnetic shielding is standard.

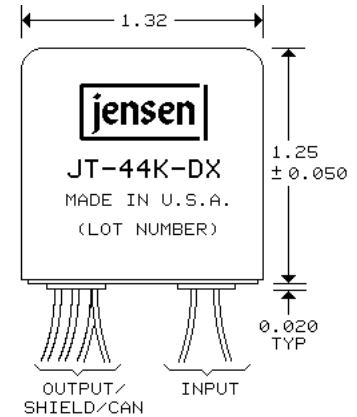

#30 AWG (7x38) UL STYLE 1061 COLOR CODED WIRE LEADS, 8" MINIMUM LENGTH

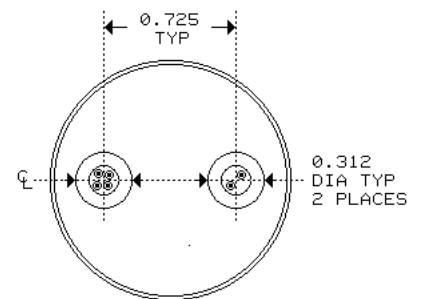

BOTTOM VIEW

RECOMMENDED MOUNTING IS WITH UR-3 CLAMP (SUPPLIED WITH TRANSFORMER)

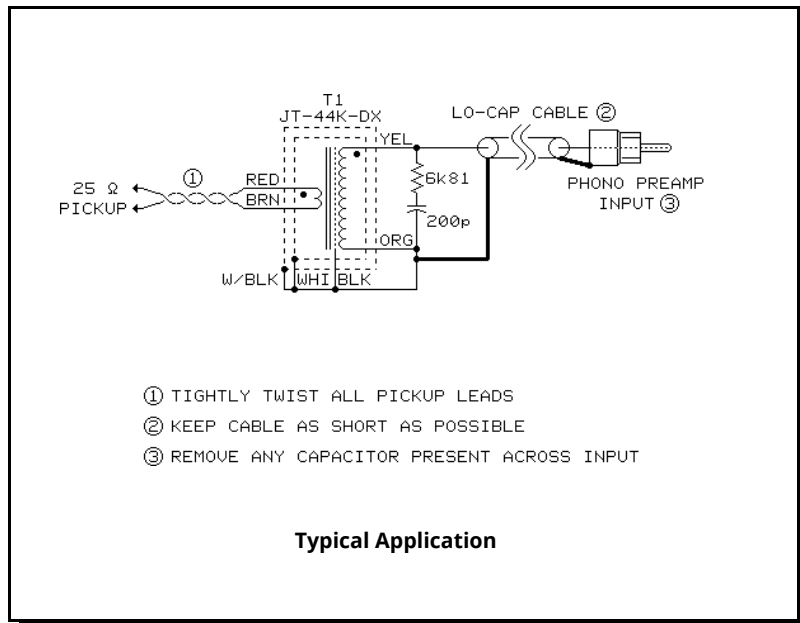

- ① TIGHTLY TWIST ALL PICKUP LEADS
- ② KEEP CABLE AS SHORT AS POSSIBLE
- ③ REMOVE ANY CAPACITOR PRESENT ACROSS INPUT

Typical Application

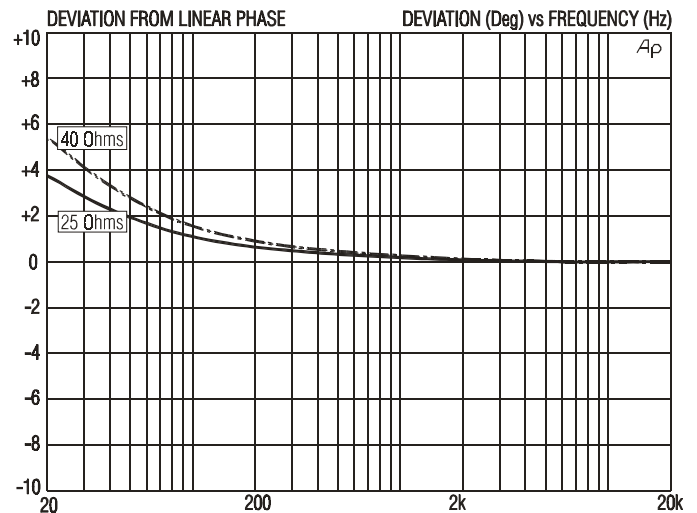
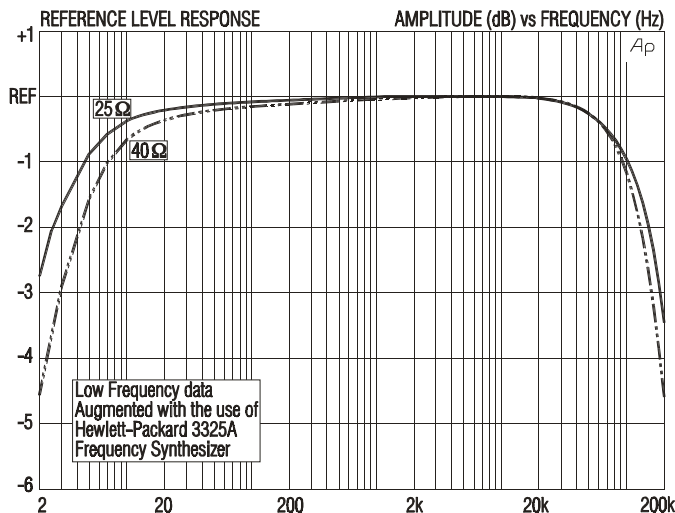

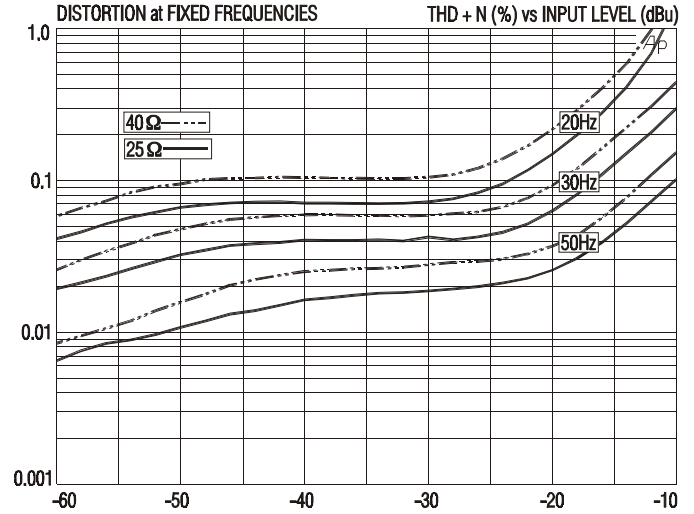
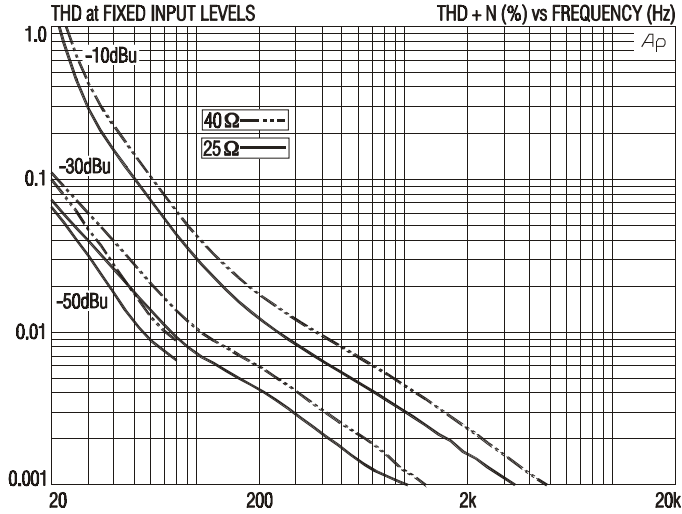

JT-44K-DX SPECIFICATIONS (unless noted, all levels are input)

PARAMETER	CONDITIONS	MINIMUM	TYPICAL	MAXIMUM
Input impedance, Zi	1 kHz, -40 dBu, test circuit 1		430 Ω	
Voltage gain	1 kHz, -40 dBu, test circuit 1	19.65 dB	19.75 dB	19.85 dB
Magnitude response, ref 1 kHz	20 Hz, -40 dBu, test circuit 1, Rs = 25 (40) Ω	-0.5 dB	-0.19 (-0.33) dB	±0.0 dB
	20 kHz, -40 dBu, test circuit 1, Rs = 25 (40) Ω	-0.1 dB	-0.02 (+0.02) dB	+0.1 dB
Deviation from linear phase (DLP)	20 Hz to 20 kHz, -40 dBu, test circuit 1		+4°	+6°
Distortion (THD)	1 kHz, -50 dBu, test circuit 1		<0.001%	
	20 Hz, -50 dBu, test circuit 1, Rs = 25 (40) Ω		0.07 (0.1) %	0.25%
Maximum 20 Hz input level	1% THD, test circuit 1, Rs = 25 (40) Ω	-15 dBu	-10.8 (-13.3) dBu	
Common-mode rejection ratio (CMRR)	60 Hz, test circuit 2		120 dB	
	3 kHz, test circuit 2	80 dB	90 dB	
Output impedance, Zo	1 kHz, -40 dBu, test circuit 1, Rs = 25 (40) Ω		3.43 (4.71) kΩ	
DC resistances	primary (BRN to RED)		3.00 Ω	
	secondary (ORG to YEL)		950 Ω	
Capacitances @ 1 kHz	primary to shield and case		305 pF	
	secondary to shield and case		208 pF	
Turns ratio		1:9.99	1:10.00	1:10.01
Temperature range	operation or storage	0° C		70° C
Breakdown voltage (see IMPORTANT NOTE below)	primary or secondary to shield and case, 60 Hz, 1 minute test duration	250 V RMS		

IMPORTANT NOTE: This device is NOT intended for use in life support systems or any application where its failure could cause injury or death. The breakdown voltage specification is intended to insure integrity of internal insulation systems; continuous operation at these voltages is NOT recommended. Consult our applications engineering department if you have special requirements.

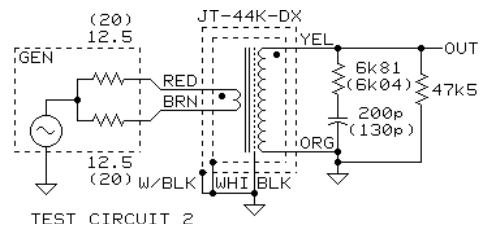
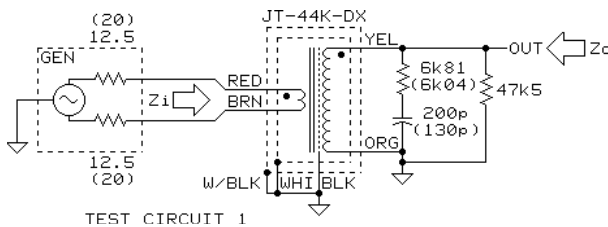

All minimum and maximum specifications are guaranteed. Unless noted otherwise, all specifications apply at 25°C. Specifications subject to change without notice. All information herein is believed to be accurate and reliable, however no responsibility is assumed for its use nor for any infringements of patents which may result from its use. No license is granted by implication or otherwise under any patent or patent rights of Jensen Transformers, Inc.